







4220 INSTALLATION INSTRUCTIONS

Section	Parameter	Display shows	Values
Input settings	Low Oil Pressure warning	Oil pressure pre-alarm	0-4bar (1.17bar)
	Low Oil Pressure shutdown	Oil pressure shutdown	0-4bar (1.03bar)
	High Temperature warning	Coolant temp pre-alarm	80-140°C (110°C)
	High Temperature shutdown	Coolant temp shutdown	80-140°C (120°C)
Timers	Mains transient delay	Mns transient delay	0-10s (2s)
	Engine transient delay	Eng transient delay	0-10s (0s)
	Start delay	Start delay	0-60m (5s)
	Return delay	Return delay	0-60m (30s)
	Preheat	Preheat	0-60m (5s)
	Crank attempt	Cranking time	0-60s (10s)
	Crank rest	Crank rest	0-60s (10s)
	Safety delay	safety on	0-30s (10s)
	Overspeed overshoot	Overspeed overshoot	0-10s (0s)
	Warming up	warm up	0-60m (0s)
	Transfer delay	Transfer delay	0-10m (1s)
	Cooling run	Cooling	0-60m (60s)
Mains (utility)	Fail to stop delay	Fail to stop	0-30s (30s)
	Low battery volts delay	Battery low delay	0-10m (30s)
	High battery volts delay	Battery high delay	0-10m (30s)
	Mains Low Voltage	Mains undervolt trip	50-360V ph-N (184V)
	Mains High Voltage	Mains overvolt trip	50-360V ph-N (276V)
	Under Speed (RPM) shutdown	Underspeed shutdown	0-6000RPM (1270)
	Under Speed (RPM) warning	Underspeed warning	0-6000RPM (1350)
	Over Speed (RPM) warning	Overspeed warning	0-6000RPM (1650)
	Over Speed (RPM) shutdown	Overspeed shutdown	0-6000RPM (1710)
	Overspeed overshoot %	Overspeed overshoot	0-10 (0%)
	Low DC Voltage	Battery low volts	0-24V (9V)
	High DC Voltage	Battery high volts	0-24V (33V)
Display	Charge Alternator Failure	Charge failure	0-24V (8V)
	Language	Language	ENGLISH, OTHER (see note below)
	LCD Contrast	Contrast	
Date/time	Date and time	Date and time	dd mmm yyyy hh:mm

NOTE:- More comprehensive module configuration is possible using the 42xx PC configuration software in conjunction with the P810 PC interface. Please contact us for further details.





NOTE:- Front panel language configuration is between English and one other PC configurable language.

ACCESSING THE FRONT PANEL CONFIGURATION EDITOR

- Press the Stop/Reset  and Info  buttons simultaneously
- If a module security PIN has been set, the PIN number request is then shown (The first * is flashing) : **ENTER PIN *******
- Press + or - buttons to adjust it to the correct value. Press  when the first digit is correctly entered.
- Repeat this process for the other digits of the PIN number.
- When  is pressed after editing the final PIN digit, the PIN is checked for validity. If the number is not correct, the editor is automatically exited. To retry you must re-enter the editor as described above.
- If the PIN has been successfully entered (or the module PIN has not been enabled) the first configurable parameter is displayed :

**Oil pressure pre-alarm
2bar 30PSI 200kPa**

EDITING A PARAMETER

- Enter the editor as described above.
- Press the + and - buttons to cycle to the parameter you wish to change.
- Press the  button to enter edit mode. When in edit mode (indicated by the flashing parameter) pressing the + and - buttons will adjust the parameter to the desired value.
- Press the  button to 'save' the value. The value will stop flashing to confirm that it has been saved.
- To select another value to edit, press the + button. Continuing to press the + and - buttons will cycle through the adjustable parameters as shown overleaf.
- To exit the front panel configuration editor at any time, press the Stop/Reset  button. Ensure you have saved any changes you have made by pressing the  button first.

NOTE:- When the editor is visible, it is automatically exited after 5 minutes of inactivity to ensure security.

NOTE:- The PIN number is automatically reset when the editor is exited (manually or automatically) to ensure security.

Deep Sea Electronics Plc.

Highfield House, Hunmanby Industrial Estate,
North Yorkshire, YO14 0PH.
ENGLAND

Tel: +44 (0)1723 890099.
Fax: +44 (0)1723 893303.
Email: sales@deepseapl.com
Web: www.deepseapl.com

Deep Sea Electronics inc.

5301 E. State St. - Suite 202
Rockford, Illinois 61108
U.S.A.

Phone: +1 (815) 316-8706
Fax: +1 (815) 316-8708
Email: dsesales@deepseausa.com
Web: www.deepseausa.com

TYPICAL WIRING DIAGRAM

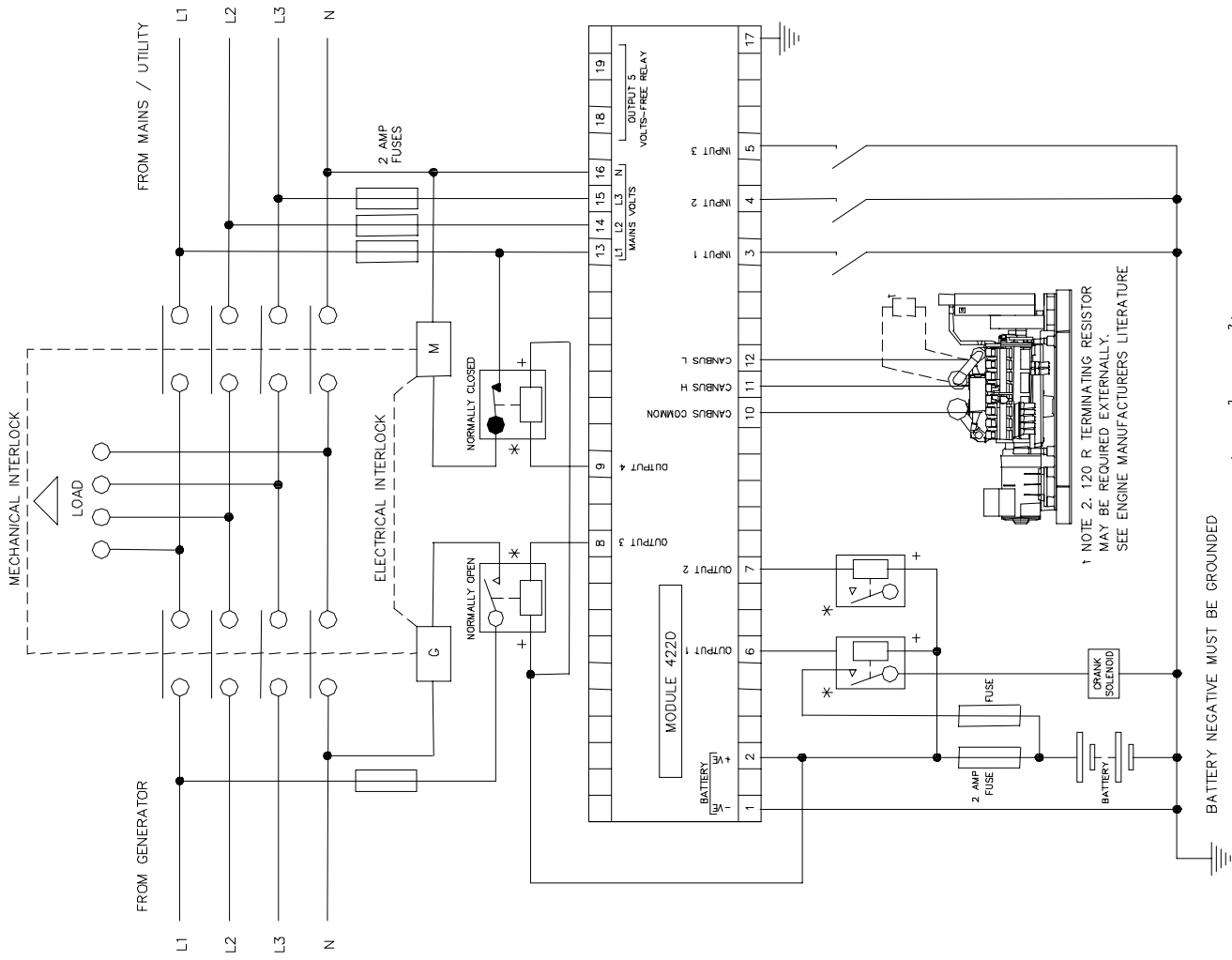

BATTERY NEGATIVE MUST BE GROUNDED

TERMINALS SUITABLE FOR 22-16 AWG (0.6mm² - 1.3mm²) FIELD WIRING

TIGHTENING TORQUE = 0.8Nm (7lb-in)

* NOTE. SOME OF THE OUTPUTS ARE SOLID STATE AND ARE NEGATIVE SWITCHING

DIMENSIONS

Module dimensions : 171mm x 115mm x 49mm (6.7" x 4.5" x 1.9")

Panel cutout : 154mm x 98mm (6.1" x 3.9")

ALTERNATIVE AC WIRING 2 phase, 3 wire (centre tap neutral)

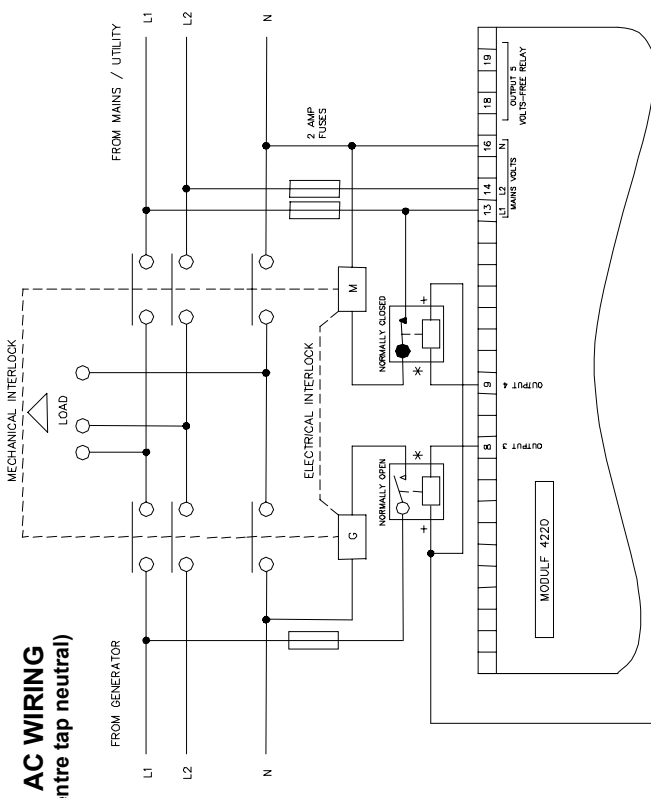

ALTERNATIVE AC WIRING 3 phase, 3 wire

